



Gas Burning Stoves





From our family to yours

With 30 years in the hearth industry, we offer you a wide range of products, all proudly carrying the President's Limited Lifetime Warranty. The years of experience, care and quality results in the creation of hearth products that possess a timeless and enduring style, worthy of a place in your home.

As the largest, private family owned hearth products and gas grill manufacturer in North America, we invite you to experience the complete family line-up of Napoleon wood, gas, electric and oil burning fireplaces, inserts and stoves. Our products are available for viewing at a dealer nearest you or online at www.napoleonfireplaces.com.

WHY NAPOLEON®?

Making your life easier...

Napoleon® gas stoves are designed to provide you absolute comfort and control at the touch of your fingertips. It's that easy. When you install a Napoleon® direct vent gas stove, you can rest assured that you will enjoy a lifetime of instant ambiance with reliable performance year after year.

An investment you can count on...

Your new Napoleon® gas stove adds value to your home while at the same time giving you uncompromising comfort and a reliable heating source. Nothing to lose and everything to gain.

Create your personal design statement...

Surround yourself with a home environment that makes you feel good, relaxed and proud to reflect your decorating style. Thousands of designer options are available to create the exact statement you have been looking for.



Highest efficiencies, maximum comfort...

Years of research, design and testing have enhanced optimum performance allowing Napoleon® products to achieve some of the highest heater rating efficiencies on the market. Napoleon® continuously surpasses industry standards not only in appearance but in efficiency and performance.

Beautiful fires, best flame in the industry...

With advanced burner technology and innovative design, Napoleon®'s flame and exclusive PHAZER™ log sets are so realistic it's hard to tell the difference from a real wood burning fire.

Authorized dealer support network...

With over 3,000 reputable authorized dealers across North America and Europe, Napoleon® provides professional and consistent training and technical support to ensure your stove is installed by a certified, reputable installation technician.

Outstanding Reliable Warranty...

Each and every Napoleon® gas stove is designed and manufactured to strict quality testing standards and backed by the President's Limited Lifetime Warranty, guaranteed to give you the solid performance you deserve. (Registered under the world recognized ISO 9001-2000)



Wolf Steel Manufacturing



Napoleon Appliance Corp.



Wolf Steel Montreal



Wolf Steel USA



30 Years of Customer Satisfaction



Wolf Steel Corporate Offices



® NAPOLEON
QUALITY FIREPLACES
Award Winning Products



Designer Options

Napoleon GDS60, Cast Iron At It's Finest

Cast iron stoves designed to meet your uncompromising expectations - The perfect blend of traditional old world charm and high tech heating performance from a comfortable 21,000 BTU's to a hearth warming 35,000 BTU's! Just one night with this stove and you'll wonder how you ever did without! The GDS60 comes in three distinct models with 6 different finishes and 6 unique overlays resulting in over 54 designer looks to harmonize with your needs and style.



Panoramic

Shown in black painted finish



Early American

Shown finished in porcelain enamel Majolica brown



Early American

Shown finished in porcelain enamel Majolica green & optional side shelves



Sandstone Decorative Brick Panels

Andirons

Painted Black



How to Customize your panoramic stove with 24 karat gold

Porcelain Enamel Finish

A glass finish fired onto metal at 1800°F to give you a deep, lustrous, scratch resistant surface

Majolica

A unique double porcelainizing process offering a rich, luxurious, long lasting finish

Majolica Green

Majolica Brown

Solid Almond

Solid Black

Also available in painted black



Direct vent stoves convert easily from top vent to rear vent



Model	BTU'S (Input)	Height		Front Width		Depth	
		Actual	Framing	Actual	Framing	Actual	Framing
GDS60	35,000	29 7/8"	N/A	25"	N/A	15 1/2"	N/A

Model	Glass Type	Glass Size		Efficiencies			Mobile Home
		Height	Width	EnerGuide	AFUE	Steady State	Approved
GDS60	Ceramic	21"	19"	63.1%	72%	78%	Yes

Minimum Clearances To Combustibles			
Model	Corner	Rear	Sides
GDS60	2"	6"	6"

ADVANCED FLAME
TECHNOLOGY
ENERGY
EFFICIENT

Features and Designer Options



Easy access hidden control panel



Solid cast iron, European design



45° venting for versatile horizontal or vertical installations



MIRRO-FLAME™
Radiant porcelain reflective rear panel



Optional Remote Control



Optional Giallo Golden Brown Finish Inset



Optional Ubatuba Green Finish Inset



Optional Lorena Slate Finish Inset

Arlington™
Cast Iron



Arlington™ - Compact in Size - Huge in Style

The Arlington™ cast iron gas stove, with its slender, space saving design and 45° venting, is perfect for smaller room applications. Even though small in size, it holds a large PHAZERAMIC™ burner system and brightly glowing ember bed, viewed through the European styled ceramic glass viewing area.

Model	BTU'S (Input)	Height		Front Width		Depth	
		Actual	Framing	Actual	Framing	Actual	Framing
GDS20	20,000	25 3/8"	N/A	19 1/4"	N/A	15 3/4"	N/A

Model	Glass Type	Glass Size		Efficiencies			Mobile Home
		Height	Width	EnerGuide	AFUE	Steady State	Approved
GDS20	Ceramic	18"	14"	60%	54.5%	78%	Yes

Minimum Clearances To Combustibles			
Model	Corner	Rear	Sides
GDS20	2"	2"	4"





The Bayfield™

Cast Iron

Designer Options



Painted Black



Majolica Brown



Winter Frost



Summer Moss



Napoleon
Wrought Iron

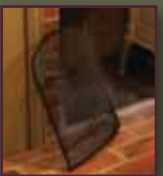

Decorative
Screen



Sandstone Decorative Brick Panels



Built-in Night Light™



Optional Giallo Golden Brown Finish Inset



Optional Ubatuba Green Finish Inset



Optional Lorena Slate Finish Inset



The Bayfield™ - Your choice of 5 designer colours

This remarkable cast iron stove comes in 5 designer colours that will look great in any home or cottage. The built-in secondary heat exchanger provides excellent heating efficiency and heat retention. Other features include a cost saving electronic ignition with battery back-up, 50% flame/heat adjustment, ceramic glass, standard on/off switch and an exclusive night light which creates a warm glow even when the stove is not operating.

Model	BTU'S (Input)	Height		Front Width		Depth	
		Actual	Framing	Actual	Framing	Actual	Framing
GDS25	24,500	23 5/8"	N/A	23 1/2"	N/A	17 1/2"	N/A

Model	Glass Type	Glass Size		Efficiencies			Mobile Home
		Height	Width	EnerGuide	AFUE	Steady State	Approved
GDS25	Ceramic	18"	15"	64.1%	73.8%	80%	Yes

Minimum Clearances To Combustibles			
Model	Corner	Rear	Sides
GDS25	2"	2"	4"



ADVANCED FLAME
TECHNOLOGY
ENERGY
EFFICIENT

Designer Options



Optional Remote Control

Andirons

Painted Black or
24 Karat Gold
Plated



Accent Bar and Doors

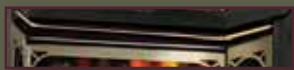

24 Karat Gold Plated

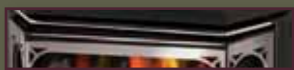

Satin Chrome

Trivets



Satin Chrome Trivet



24 Karat Gold Plated Trivet



Shown with 24 karat gold plated door, trivet and accent bar



Shown with satin chrome door, trivet and accent bar

GDS28 - Dynamic Compact Design

Good things do come in small packages! If you have limited space but still desire the beauty and convenience of a gas stove... the GDS28 is the answer! Offering a variable heat range up to as much as 30,000 BTU's, this stove may be compact in stature, but not in power!

Model	BTU'S (Input)	Height		Front Width		Depth	
		Actual	Framing	Actual	Framing	Actual	Framing
GDS28	30,000	26 3/4"	N/A	22 1/2"	N/A	18 1/2"	N/A

Model	Glass Type	Glass Size		Efficiencies			Mobile Home
		Height	Width	EnerGuide	AFUE	Steady State	Approved
GDS28	Ceramic	12 3/8"	21"	54.7%	76%	85%	Yes

Minimum Clearances To Combustibles			
Model	Corner	Rear	Sides
GDS28	1"	2"	7"





Shown with satin chrome plated door, trivet and accent bar

GDS50 - Turbo Boost Heating Power

This sophisticated gas stove offers many benefits - a built-in blower, extra large heat exchanger, easily accessible controls and solid body construction and a triple state-of-the-art burner system allowing superior heating efficiency. This, combined with clean-burning, environmentally friendly technology, makes the GDS50 the perfect choice to add long-lasting value to your home!

Shown with 24 karat gold plated door, trivet and accent bar

Model	BTU'S (Input)	Height		Front Width		Depth	
		Actual	Framing	Actual	Framing	Actual	Framing
GDS50	44,000	30 3/4"	N/A	28 1/4"	N/A	21 5/8"	N/A

Model	Glass Type	Glass Size		Efficiencies			Mobile Home
		Height	Width	EnerGuide	AFUE	Steady State	Approved
GDS50	Ceramic	13 7/8"	25 3/4"	70%	77%	84%	Yes

Minimum Clearances To Combustibles			
Model	Corner	Rear	Sides
GDS50	1"	2"	7"

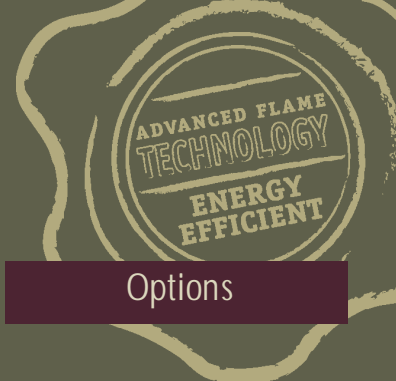

Options



COOKMATE™

The unique grid pattern moulded into the cast aluminum captures and retains the maximum amount of heat and transfers it directly to your frying pan or pot. The Cookmate™ simply replaces your existing trivet



Optional Remote Control

Andirons

Painted Black



Accent Bar and Doors

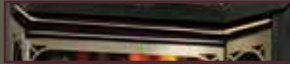

24 Karat Gold Plated

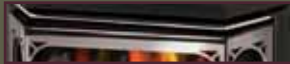

Satin Chrome

Trivets



Satin Chrome Trivet



24 Karat Gold Plated Trivet

Gas Stove Dimensions

Model

GDS20
Arlington™

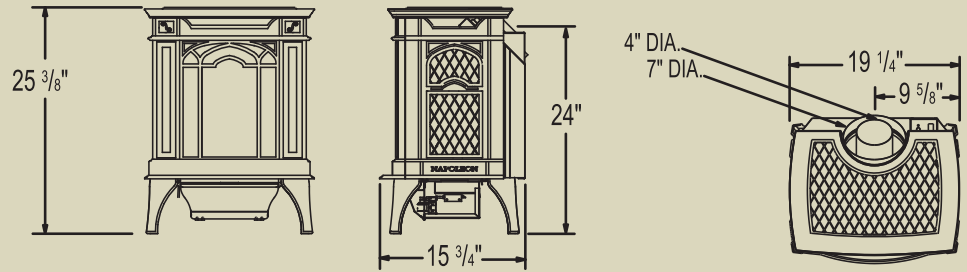

GDS25
Bayfield™

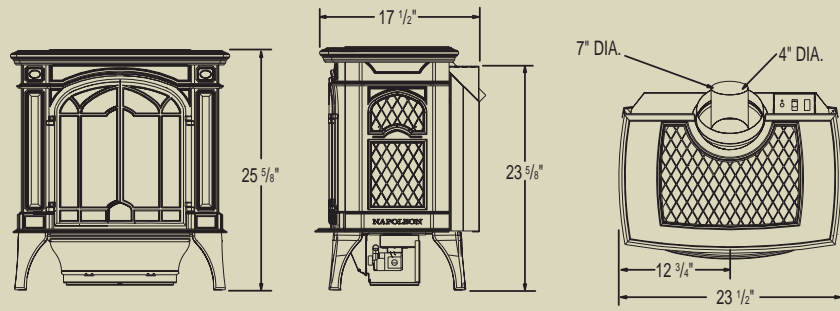

GDS28

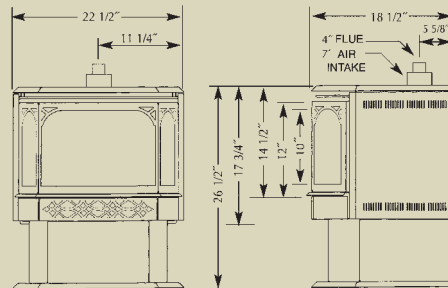

GDS50

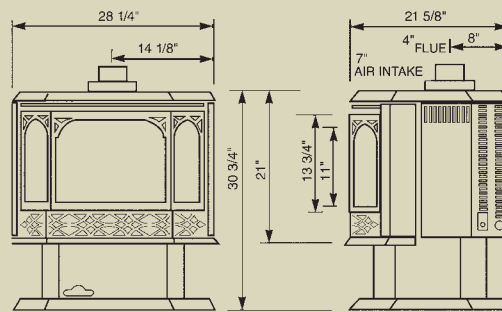

GDS60

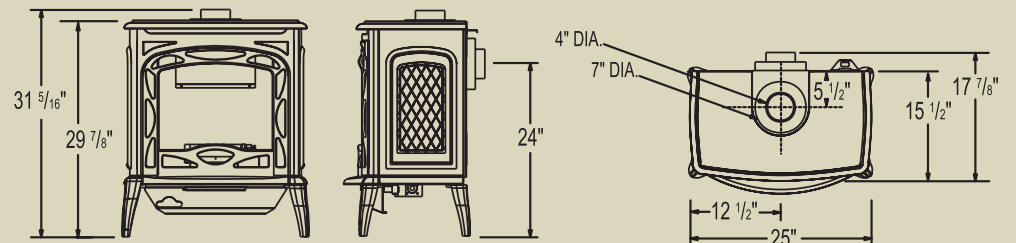



Outstanding Features of Napoleon's Advanced Technology



Advanced Burner Technology

Napoleon's sophisticated burner system offers superior flame technology. Strategically placed burner ports create the most realistic flames in the industry.



Finely Tuned Precision Valves

Surrounded with a protective cast aluminum jacket, the precision valves allow for ultimate reliability and 100% SAFE GUARD™ gas control system.



Exclusive Night Light™

The exclusive ceramic glass night light illuminates the decorative firebox even when the fireplace is turned off. (GDS25)



Outstanding Craftsmanship

Napoleon's distinctive porcelain enamel is glass finish baked onto cast iron at 1800° F to give you a deep, lustrous, scratch resistant and easy to clean finish, guaranteed to last a lifetime.

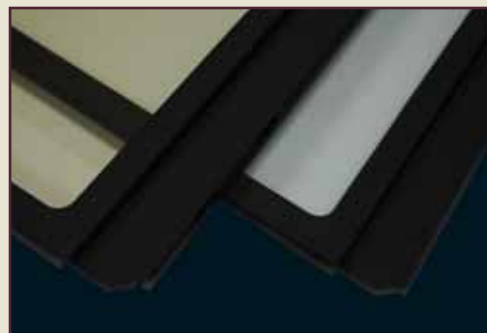

High Heat Ceramic Glass

Unlike tempered glass, ceramic glass is made to withstand extreme high heat temperatures, allowing maximum radiant heat performance and safety.



Whisper Quiet™ Heat Circulating Blower System





The extreme heat resistant "H" class bearings featured in Napoleon's superior heat circulating blower, creates a lasting "whole home" comfort with adjustable high & low speeds.



Convenient Remote Control

Napoleon's Advantage Plus™ remote with digital read out and thermostatic control adjusts the flame, heat and blower... giving you the comfort level you need.

Legend

-  Advanced Burner System
YELLOW DANCING FLAME™
-  Optional Heat Circulating Blower
(Standard with GDS28 & GDS50)
-  Optional Full Function Digital Remote
-  No Electricity Required to Light or Operate
-  Money Saving

Experience Napoleon's Impressive Product Selection Online



Please visit our website for more information on our complete line of wood, gas, oil and electric fireplaces, stoves and inserts as well as the Napoleon Waterfall collection or to find the dealer nearest you.

We also have a complete line of outdoor living products including an outdoor gas fireplace, patio heaters, an outdoor gas firepit and gourmet gas grills.



Other Napoleon Products



Fireplace Inserts



Outdoor Living Products



Wood Burning Fireplaces



Cast Iron Gas Stoves



Waterfall Collection



Vent Free Fireplaces



Electric Fireplaces



Direct Vent Fireplaces



Gourmet Gas Grills

Napoleon stoves are certified for emissions to EPA phase 2 1990 and DEQ 1988 Standards and safety tested by Warnock Hersey to North American Standards. CSA B366.2, ULC S627, ULC S628 and UL 1482. Consult your owner's manual for complete installation instructions and check all local and national building codes. All specifications and designs are subject to change without notice to allow for on-going product improvement. Images may not be exactly as shown. Actual enamel colours might be slightly different as shown in brochure. Patent U.S. 5,307,801, 5,303,693, 75054, 417497 - Can. 2,073,411, 2,082,915, 74589 © Wolf Steel Ltd. Patents Pending # 6944982B2 Napoleon® is a registered trademark of Wolf Steel Ltd.



- 103 Miller Drive, Crittenden, Kentucky, USA 41030
- 24 Napoleon Road, Barrie, Ontario, Canada L4M 4Y8
- 7200 Trans Canada Highway, Montreal, Quebec, Canada H4T 1A3

Tel: 705-721-1212 Fax 705-722-6031
www.napoleonfireplaces.com
www.fireplacedesignstudio.com

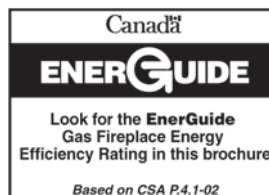

Authorized Dealer

